

Power

MOMO-F Power P030 Fixture Guide

KKDC

Indoor/Outdoor | Recessed | Output up to 2850lm/m (869lm/ft)



Key applications

- ✓ Bathrooms
- ✓ Building facades
- ✓ Direct lighting
- ✓ Exterior
- ✓ In ground
- ✓ Interior
- ✓ Pathways/driveways
- ✓ Uplighting
- ✓ Wall grazing
- ✓ Wet area

Key features

- ✓ Custom lengths
- ✓ Constant Voltage (CV)
- ✓ Diffusion: spotting
- ✓ Glare control options
- ✓ In ground walkover
- ✓ IP44 moisture resistant
- ✓ IP67 waterproof
- ✓ Lens options

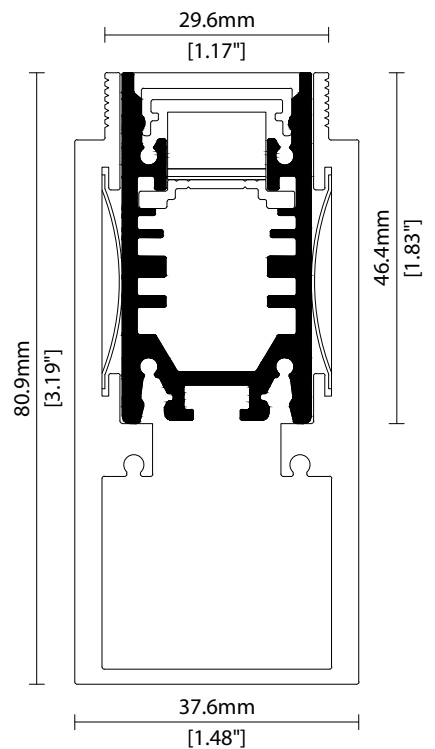

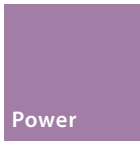

MOMO-F Power P030

Specification sheet



Dimensions	H46.4/W25/L260-2010mm (H1.83/W0.98/L10.24-79.13in)
PCB Cut-point	250mm increment/2000mm max (9.84in increment/78.74in max)
LED Pitch	35.7mm-28LED/m (1.40in - 8LED/ft)
Chip	h-line
Cover/Optics	Clear/12°/25°/60°/Spread lens/No lens/Micro louvre/Honeycomb louvre
CCT	h-line: 2700K/3000K/3500K/4000K/5000K
LED binning	h-line: 3-step MacAdam ellipse
CRI	≥94
Lifetime	50,000 hours @ 25°C (50,000 hours @ 77°F)
Operating temp	T _a = -25 to 40°C (T _c max = 76.4°C) T _a = -13 to 104°F (T _c max = 170°F)
IP Rating	IP67
Finish	Silver anodised
Mounting	Ground recessed or surface mounted with concealed clips
Power feed	Sheathed hardwire tails or male/female connectors
Control	0-10V/1-10V/DMX/DALI



LED Grading Key

Exclusive Grade
h-line* *KKDC tuned
 Constant Voltage Lensed High CCT range
 Power LED
 3-step CCT range
 (4-step for 5000K)

Power consumption	Supply voltage	Supply current
30W/m (9.14W/ft)	24V DC	1.25A/m (0.38A/ft)

Performance Data (3000K)

h-line	R1	R2	R3	R4	R5	R6	R7	R8	R9	R10	R11	R12	R13	R14
	95	97	99	97	96	98	93	84	83	94	99	88	97	99

	Clear + 12°	Clear + 25°	Clear + 60°	Clear + Spread	No lens	Clear Cover + Micro Louvre	Clear Cover + Honeycomb louvre	CRI	R9	Rf	Rg
h-line	2850lm/m (869lm/ft) 95lm/W	2760lm/m (841lm/ft) 92lm/W	2730lm/m (832lm/ft) 91lm/W	2400lm/m (731lm/ft) 80lm/W	2490lm/m (759lm/ft) 83lm/W	-60% Output when combined with Cover and Lens options	-40% Output when combined with Cover and Lens options	94	70	-	-

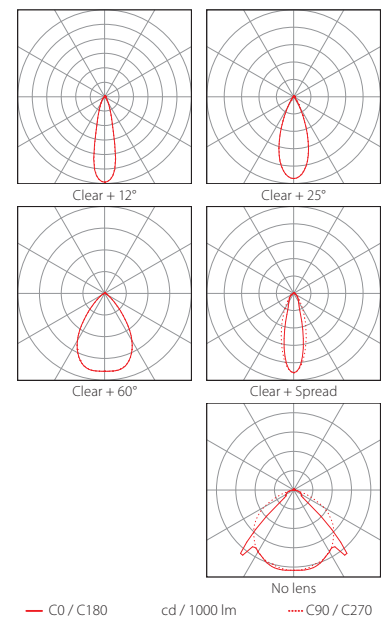
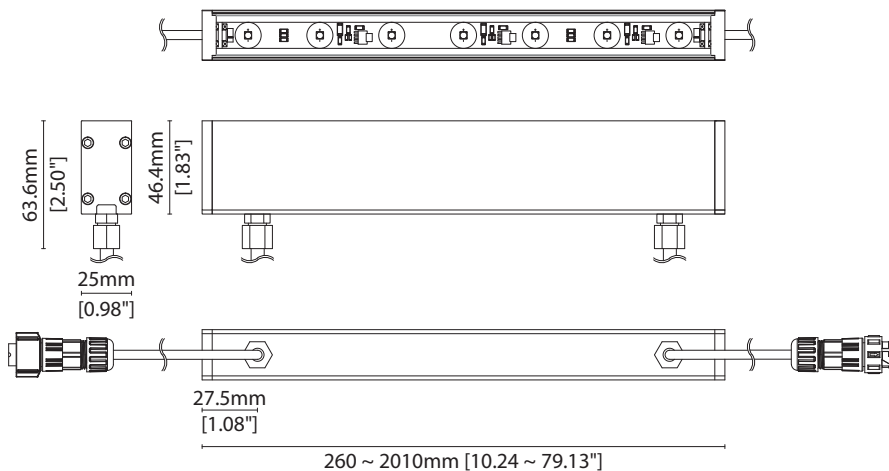

Data derived from independent UKAS/IESNA LM-79-08 accredited testing of production samples.

MOMO-F Power P030

Code Table



FIXTURE

Model	Finish	Cover/Lens ¹	Grade ²	LED	Colour (CCT)	Length Availability ³	IP	Cable Length	Power Feed ⁴	Optics	Input												
MOMO-F Power	MF	Silver Anodised	SA	Clear	B	h	h	P030	P030	2700K	27	m	260-2010mm 250mm increments	IP67 ⁵	67	300mm/ 11.81"	0300	Single ø6.3mm sheath tail	S00B	No lens	xx	DC 24V	g
		Clear+ Micro louvre		K	3000K	30						i	10.24-79.13in 9.84in increments					Double ø6.3mm sheath tail	D00B	12°	12		
		Clear+ Honeycomb louvre		Z	3500K	35												Single ø6.3mm sheath IP67 connector ⁶	S67B	25°	25		
					4000K	40												Double ø6.3mm sheath IP67 connector ⁶	D67B	60°	60		
					5000K	50														Spread	SL		

¹ Refer to **Cover/Lens Options** on **Options** pages

² Refer to **LED Grading Key** on **Specification sheet** page

³ Refer to **Length Availability List** or enter total run length instead of length code

⁴ Refer to **Power Feed Options** on **Options** pages

⁵ Due to the clear, flush potted polyurethane top layer on IP67 MOMO-F Power a colour shift of +/- 20K should be expected

⁶ IP67 connectors are used for both IP67 and IP44 product housings

Code Example:

MF	-	SA	-	B	-	h	-	P030	-	35	-	m	-	510	-	67	-	0300	-	D67B	-	xx	-	g
MOMO-F Power		Silver Anodised		Clear		h		P030		3500K		m		510mm		IP67		300mm/11.81"		Double ø6.3mm sheath IP67 connector		No lens		DC 24V

ACCESSORIES

Mounting Accessories

KKF3-03 Ground box

* Refer to **Mounting accessories** on **Accessories** pages

Connection Accessories

CN67-2P-0300 IP67 2 PIN male & female 300mm/11.81" pair

CN67-2P-1000 IP67 2 PIN male & female 1000mm/39.37" pair

CN67-2P-3000 IP67 2 PIN male & female 3000mm/118.11" pair

* Refer to **Power feed** on **Accessories** pages

Exterior Junction Boxes

KKJB-07 IP67 Slim J-Box

KKJB-07R Potting Resin for IP67 Slim J-Box

* Refer to **Exterior Junction Boxes** on **Accessories** pages

PSU/Driver

0-10V/1-10V/DALI/DMX

* Refer to **Driver/PSU Options** page for details or provide requirement and KKDC to offer the suitable option

MOMO-F Power P030

Length Availability List



Length Code		Fixture Length ¹		LED Strip ²		End Cap Dimension ³		Wattage (W)	Output (lm)
Metric	Imperial(US)	Metric	Imperial(US)	Metric	Imperial(US)	Metric	Imperial(US)		3000K (Test Data)
m0260	i0010	260mm	10.24in	250mm	9.84in	10mm	0.39in	7.50	756
m0510	i0020	510mm	20.08in	500mm	19.69in	10mm	0.39in	15.00	1512
m0760	i0030	760mm	29.92in	750mm	29.53in	10mm	0.39in	22.50	2268
m1010	i0040	1010mm	39.76in	1000mm	39.37in	10mm	0.39in	30.00	3024
m1260	i0050	1260mm	49.61in	1250mm	49.21in	10mm	0.39in	37.50	3780
m1510	i0059	1510mm	59.45in	1500mm	59.06in	10mm	0.39in	45.00	4536
m1760	i0069	1760mm	69.29in	1750mm	68.90in	10mm	0.39in	52.50	5292
m2010	i0079	2010mm	79.13in	2000mm	78.74in	10mm	0.39in	60.00	6048

¹ Actual total overall length of light fixture (LED strip + end caps + void/wire hole)

² Actual length of PCB strip

³ Actual length of 2x end caps

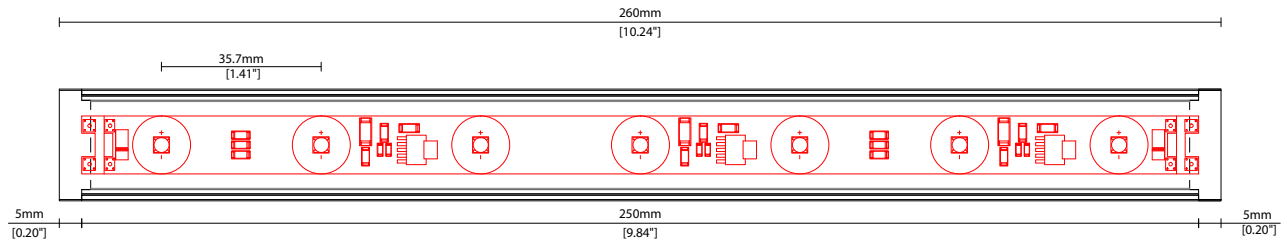

COVER/LENS OPTIONS

* Options are an integral part of the fixture ordering codes. Please refer to **Code Table** pages.



B 12 Clear Cover 12° lens
W25.0/H46.4mm (W0.98/H1.83")

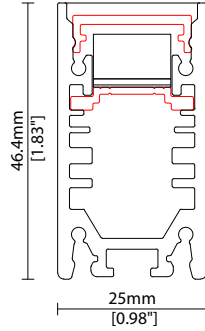

B 25 Clear Cover 12° lens
W25.0/H46.4mm (W0.98/H1.83")

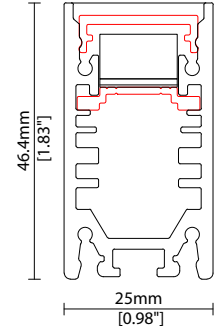

B 60 Clear Cover 12° lens
W25.0/H46.4mm (W0.98/H1.83")

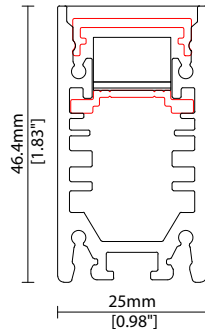

B SL Clear Cover spread lens
W25.0/H46.4mm (W0.98/H1.83")

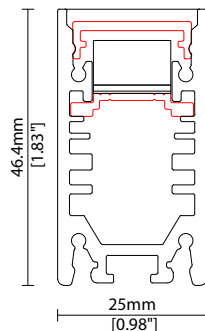
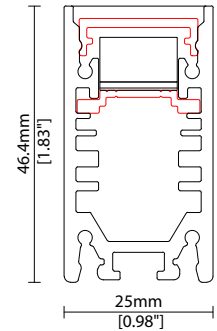

B zz Clear Cover no lens
W25.0/H46.4mm (W0.98/H1.83")



K Clear + Micro louvre
W25.0/H46.4mm (W0.98/H1.83")

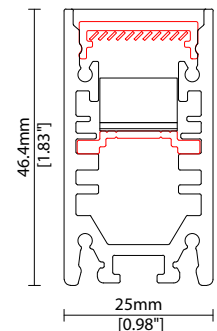



MOMO-F Power P030 Options



COVER/LENS OPTIONS

* Options are an integral part of the fixture ordering codes. Please refer to **Code Table** pages.

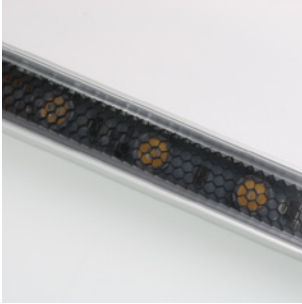

Z Clear + Honeycomb louvre
W25.0/H46.4mm (W0.98/H1.83")

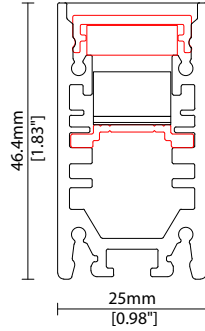

POWER FEED OPTIONS

0300 S00B 300mm (11.81") Single Ø6.3mm sheath tail

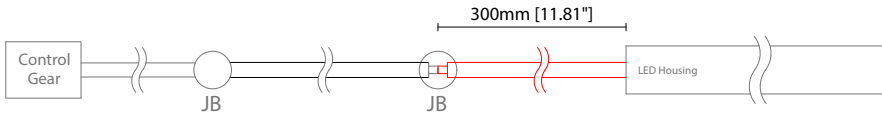

0300 D00B 300mm (11.81") Double Ø6.3mm sheath tail

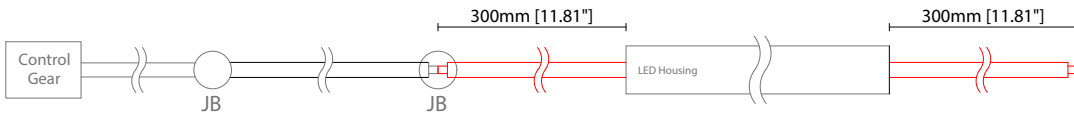

0300 S67B 300mm (11.81") Single Ø6.3mm sheath IP67 connector

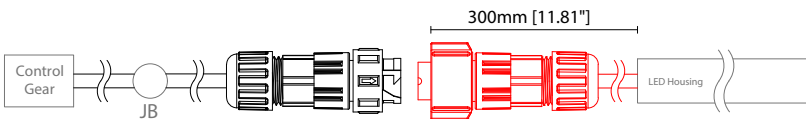

0300 D67B 300mm (11.81") Double Ø6.3mm sheath IP67 connector

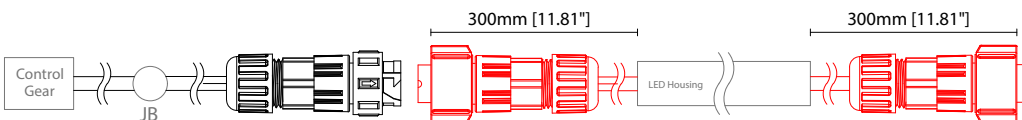

IP67 2 Pin Connector

Female connector
2 PIN (IP67)

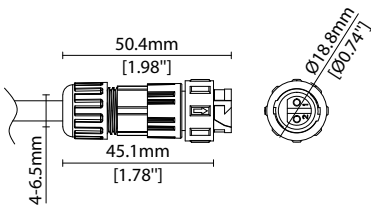

Male connector
2 PIN (IP67)

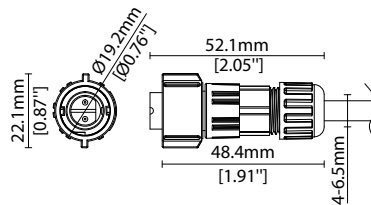

Key

- Control Gear Power supply, sub-controllers & control systems
- JB Junction box / cable connection

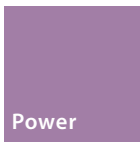

MOMO-F Power P030 Accessories



MOUNTING ACCESSORIES

Note: Accessories are to be ordered separately with corresponding code shown below.



KKCP-11

Concealed clip

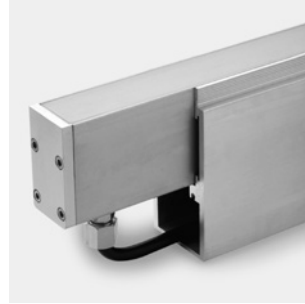
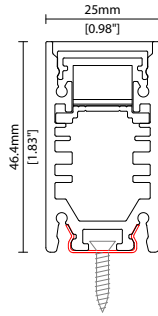

KKFR-03*

Ground box

Anodised aluminium finish
W37.6/H80.9mm (W1.48/H3.19")

* Specify length to match
MOMO-F Power

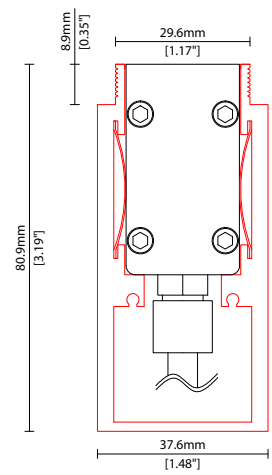

POWER FEED

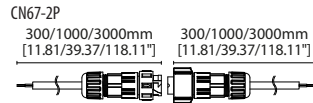

- CN67-2P-0300** 300mm (11.81in) pair
- CN67-2P-1000** 1000mm (39.37in) pair
- CN67-2P-3000** 3000mm (118.11in) pair

IP67

2 PIN male + female connector set

EXTERIOR JUNCTION BOXES



KKJB-07

IP67 Slim J-Box
(including type A,B,C, D bushings)



KKJB-07R

Potting resin for IP67 Slim J-Box

KKDC CONTROL



KKDM-06 1-10V

visDIM dimmable sub-controller
(4 x 8A max @ 12-36V)

IP20
Plastic housing
L170/W59/H29mm
(L6.69/W2.32/H1.14in)



KKSC-05 DMX

visDIM dimmable sub-controller
(4 x 5A max @ 12-36V)

IP20
Plastic housing
L170/W53.4/H28mm
(L6.69/W2.10/H1.10in)



KKDL-02 DALI

visDIM dimmable sub-controller
(4 x 8A max @ 12-36V)

IP20
Plastic housing
L170/W59/H29mm
(L6.69/W2.32/H1.14in)



KKDL-03 DALI

visDIM dimmable sub-controller
(4 x 5A max @ 12-36V)

IP20
Plastic housing
L166/W53.4/H23mm
(L6.54/W2.10/H0.91in)

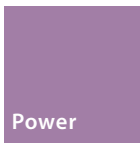

MOMO Power P030

Driver/PSU Options



AVAILABLE PSU OPTIONS

Control Mode	PSU (Order Code)	Input Voltage AC	Output Voltage DC	Rated Output Current	Rated Power	Dim %	IP Rating
Switched	CEN-60-24	90-295V	24V	2.5A	60W	-	IP67
	HLG-60H-24	90-305V	24V	2.5A	60W	-	IP67
	HLG-100H-24	90-305V	24V	4.0A	100W	-	IP67
	HLG-150H-24	90-305V	24V	6.3A	150W	-	IP67
	HLG-240H-24	90-305V	24V	10A	240W	-	IP67
0-10V (1-10V)	PWM-40-24	90-305V	24V	1.67A	40W	100-0.15 (100-10)	IP67
	PWM-60-24	90-305V	24V	2.5A	60W	100-0.15 (100-10)	IP67
	PWM-90-24	90-305V	24V	3.67A	90W	100-0.15 (100-10)	IP67
	PWM-120-24	90-305V	24V	5.0A	120W	100-0.15 (100-10)	IP67
DALI	LIN100A1	120-277V	24V	1A per channel	100W	100-0.1	IP66/IP40
DMX RGB	LIN100A1	120-277V	24V	1.33A per channel	100W	100-0.1	IP66/IP40
DMX RGBW	LIN100A1	120-277A	24V	1A per channel	100W	100-0.1	IP66/IP40

Flicker Free Options - Combination of PSU+ sub-controller

Control Mode	PSU (Order Code)	Sub-controller (Order Code)	Input Voltage AC	Output Voltage DC	Rated Output Current	Rated Power	Dim %	IP Rating PSU/ Sub-controller
0-10V or 1-10V	CEN-60-24	KKDM-06	90-295V	24V	2.5A	60W	100-0.9	IP67/IP20
	HLG-60H-24	KKDM-06	90-295V	24V	2.5A	60W	100-0.9	IP67/IP20
	HLG-100H-24	KKDM-06	90-295V	24V	4.0A	100W	100-0.9	IP67/IP20
	HLG-150H-24	KKDM-06	90-295V	24V	6.3A	150W	100-0.9	IP67/IP20
	HLG-240H-24	KKDM-06	90-295V	24V	10.0A	240W	100-0.9	IP67/IP20
DALI	CEN-60-24	KKDL-02/03	90-295V	24V	2.5A	60W	100-0.1	IP67/IP20
	HLG-60H-24	KKDL-02/03	90-305V	24V	2.5A	60W	100-0.1	IP67/IP20
	HLG-100H-24	KKDL-02/03	90-305V	24V	4.0A	100W	100-0.1	IP67/IP20
	HLG-150H-24	KKDL-02/03	90-305V	24V	6.3A	150W	100-0.1	IP67/IP20
	HLG-240H-24	KKDL-02/03	90-305V	24V	10.0A	240W	100-0.1	IP67/IP20
DMX RGB	CEN-60-24	KKSC-05	90-295V	24V	2.5A	60W	100-0.9	IP67/IP20
	HLG-60H-24	KKSC-05	90-305V	24V	2.5A	60W	100-0.9	IP67/IP20
	HLG-100H-24	KKSC-05	90-305V	24V	4A	100W	100-0.9	IP67/IP20
	HLG-150H-24	KKSC-05	90-305V	24V	6.3A	150W	100-0.9	IP67/IP20
	HLG-240H-24	KKSC-05	90-305V	24V	10.0A	240W	100-0.9	IP67/IP20

¹ The items shown above cover the most frequently used specification but does not exhaust the possible options

² PSU and/or driver can be chosen from the table, or KKDC may recommend the best option upon receipt of the controls requirement and installation environment

³ Electrical shop drawing will include detailed information of PSU and relevant control drivers

⁴ Cut sheets are available on the controls section of www.kkdc.lighting or upon request